

# HIGH PROFILE LED BEACONS

## FLEET *PLUS*



23803



Switch 766163  
(sold separately)



- 10 Year Warranty
- BatteryCheck™
- AutoDim™
- Synchronization
- Zero EMI

(definitions refer to page 2)

### Features

- SAE J845 (2013) Class 1 (CA13 23803 only)
- Anodized aluminum open base
- High strength polycarbonate dome and lens with UV inhibitors
- Fully encapsulated electronics for rugged durability; protecting against vibration and moisture

### Available Colors



### Recommended Mounting Solution

(sold separately - See page 64 for more options)



### Dimensions

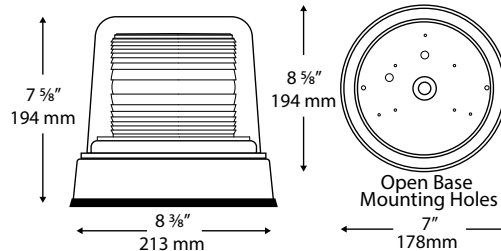

Available Models								Replacement parts		
Part #	Dome/Lens	Vdc	Amps	Lumens	SAE	Mounting	# Patterns	Dome	Lens	Circuit
23802	Clear/Red	12-24	0.5-1.5	1080	-	PM	13	134-1-C	300-R	79890
✓ 23803	Clear/Amber	12-24	0.5-1.5	1080	Class 1	PM	13	134-1-C	300-A	79890
23804	Clear/Blue	12-24	0.5-1.5	828	Class 1	PM	13	134-1-C	300-B	79895
✓ 23805	Amber/Clear	12-24	0.5-1.5	1080	Class 1	PM	13	134-1-A	300-C	79890
23806	Clear/Clear	12-24	0.5-1.5	1080	Class 1	PM	13	134-1-C	300-C	79864

✓ = Top Seller | PM = Permanent Mount

# HIGH PROFILE LED BEACONS

## FLEET



200A-12V-A



Switch 766163  
(sold separately)

### Features

- SAE J845 (2013) Class 1 requirements (Photometrics only)
- Anodized aluminum open base
- High strength polycarbonate dome and lens with UV inhibitors
- Fully encapsulated electronics for rugged durability; protecting against vibration and moisture
- User selectable flash patterns; single (60 FPM), double (107 FPM) or quad (160 FPM)
- CSA Approved (12 Volt models)
- 4 Year Warranty

### Available Colors



### Recommended Mounting Solution

(sold separately - See page 64 for more options)



### Dimensions

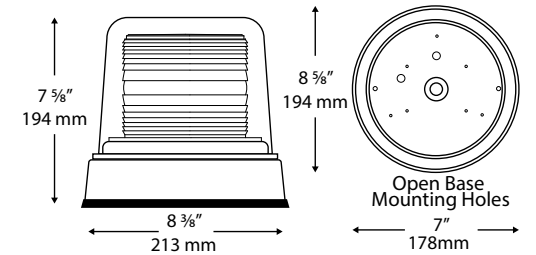

Available Models									Replacement parts		
Part #	Dome/Lens	Vdc	Amps	Lumens	SAE	Mounting	CSA	# Patterns	Dome	Lens	Circuit
✓ 200A-12V-A	Clear/Amber	12-80	0.5	912	Class 1	PM	✓	3	134-1-C	300-A	79862
200A-12V-B	Clear/Blue	12-80	0.5	912	Class 2	PM	✓	3	134-1-C	300-B	79862
200A-12V-C	Clear/Clear	12-80	0.5	912	Class 2	PM	✓	3	134-1-C	300-C	79862
200A-12V-G	Clear/Green	12-80	0.5	912	-	PM	✓	3	134-1-C	300-G	79862
200A-12V-R	Clear/Red	12-80	0.5	912	Class 2	PM	✓	3	134-1-C	300-R	79862
✓ 200A-72V-A	Clear/Amber	72-125	0.1	912	Class 1	PM		3	134-1-C	300-A	79825
200A-72V-C	Clear/Clear	72-125	0.1	912	Class 2	PM		3	134-1-C	300-C	79825
200A-72V-R	Clear/Red	72-125	0.1	912	Class 2	PM		3	134-1-C	300-R	79825

✓ = Top Seller | PM = Permanent Mount

# HIGH PROFILE LED BEACONS

## FLEET PLUS



23860



23835



Switch 766163  
(sold separately)

# HIGH PROFILE LED BEACONS

## FLEET



27151



27152



Switch 766163  
(sold separately)

- 10 Year Warranty
- BatteryCheck™
- AutoDim™
- Synchronization
- Zero EMI

(definitions refer to page 2)

### Features

- SAE J845 (2013) Class 1 requirements
- High strength polycarbonate construction with UV inhibitors
- Fully encapsulated electronics for rugged durability; protecting against vibration and moisture



### Features

- SAE J845 (2013) Class 1 requirements (Photometrics only)
- High strength polycarbonate construction with UV inhibitors
- Fully encapsulated electronics for rugged durability; protecting against vibration and moisture
- User selectable flash patterns; single (60 FPM), double (107 FPM) or quad (160 FPM)
- 4 Year Warranty

### Available Colors



### Recommended Mounting Solution

(sold separately - See page 64 for more options)



### Dimensions

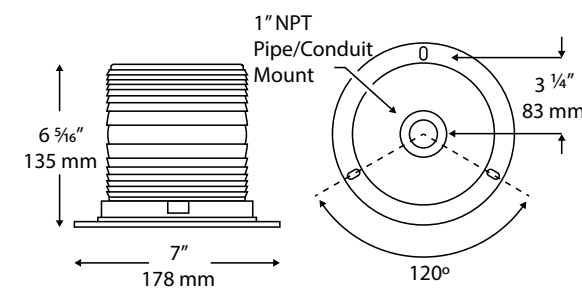

Available Models								Replacement parts	
Part #	Lens	Vdc	Amps	Lumens	SAE	Mounting	# Patterns	Lens	Circuit
✓ 23835	Amber	12-24	0.5-1.5	1,080	Class 1	FL	13	877307	79896
23840	Blue	12-24	0.5-1.5	828	Class 1	FL	13	877308	79898
23860	Clear	12-24	0.5-1.5	1,080	Class 1	FL	13	877309	79865

✓ = Top Seller | FL = Flange Mount

### Available Colors



### Recommended Mounting Solution

(sold separately - See page 64 for more options)



### Dimensions

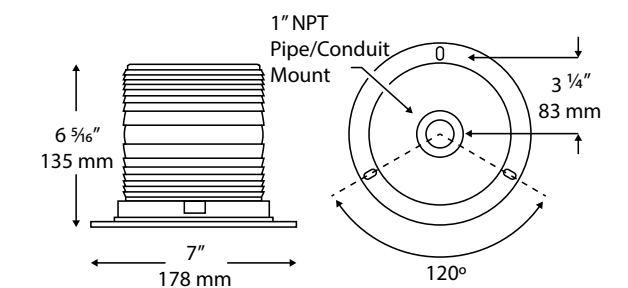

Available Models								Replacement parts	
Part #	Lens	Vdc	Amps	Lumens	SAE	Mounting	# Patterns	Lens	Circuit
✓ 27151	Clear	12-80	0.1-0.5	912	Class 1	FL	3	877309	79866
27152	Amber	12-80	0.1-0.5	912	Class 1	FL	3	877307	79866
27153	Blue	12-80	0.1-0.5	912	Class 1	FL	3	877308	79866

✓ = Top Seller | FL = Flange Mount

# MEDIUM PROFILE LED BEACONS FLEET PLUS



23816



23815



Switch 766163  
(sold separately)

### Features

- SAE J845 (2013) Class 1 requirements
- High strength polycarbonate construction with UV inhibitors
- Fully encapsulated electronics for rugged durability; protecting against vibration and moisture
- AutoDim™ and Synchronization not available in magnetic mount versions

- 10 Year Warranty
- BatteryCheck™
- AutoDim™
- Synchronization
- Zero EMI

(definitions refer to page 2)

### Available Colors



### Recommended Mounting Solution

(sold separately - See page 64 for more options)



Available Models								Replacement parts	
Part #	Lens	Vdc	Amps	Lumens	SAE	Mounting	# Patterns	Lens	Circuit
✓ 23815	Amber	12-24	0.1-1.5	1080	Class 1	FL	13	300-S-A	79890
23819	Blue	12-24	0.1-1.5	828	Class 1	FL	13	300-S-B	79895
✓ 23827	Clear	12-24	0.1-1.5	1080	Class 1	FL	13	300-S-C	79864
23816	Amber	12	0.1-1.5	1080	Class 1	MM	13	300-S-A	79890
23820	Blue	12	0.1-1.5	828	Class 1	MM	13	300-S-B	79895
* 23810	Clear	12-24	0.1-1.5	1380	Class 1	FL	13	300-S-C	-
* 23811	Red	12-24	0.1-1.5	1380	Class 2	FL	13	300-S-R	-
* 23812	Clear	12	0.1-1.5	1380	Class 1	MM	13	300-S-C	-

✓ = Top Seller | MM = Magnetic Mount | FL = Flange Mount | \*Top emitting option

### Dimensions

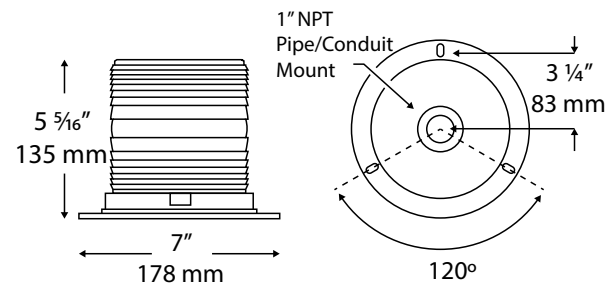

# MEDIUM PROFILE LED BEACONS FLEET



27001



27021  
Magnet Mount



27112  
Vacuum magnet Mount



27061  
Mirror Bracket Mount



Switch 766163  
(sold separately)

### Features

- SAE J845 (2013) Class 1 requirements (Photometrics only)
- High strength polycarbonate construction with UV inhibitors
- Fully encapsulated electronics for rugged durability; protecting against vibration and moisture
- User selectable flash patterns; single (60 FPM), double (107 FPM) or quad (160 FPM)
- Multiple mounting options for your application
- 4 Year Warranty

### Dimensions

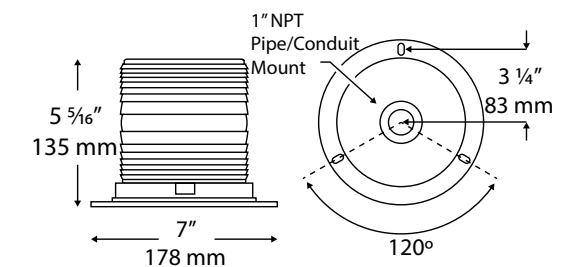

### Available Colors



### Recommended Mounting Solution

(sold separately - See page 64 for more options)



Available Models								Replacement parts	
Part #	Lens	Vdc	Amps	Lumens	SAE	Mounting	# Patterns	Lens	Circuit
✓ 27001	Amber	12-80	0.5	912	Class 1	FL	3	300-S-A	79862
27002	Blue	12-80	0.5	912	Class 2	FL	3	300-S-B	79862
27003	Clear	12-80	0.5	912	Class 2	FL	3	300-S-C	79862
27011	Amber	72-125	0.5	912	Class 1	FL	3	300-S-A	79825
27013	Clear	72-125	0.5	912	Class 2	FL	3	300-S-C	79825
27015	Red	72-125	0.5	912	Class 2	FL	3	300-S-R	79825
✓ 27021	Amber	12	0.1-0.5	912	Class 1	MM	3	300-S-A	79862
✓ 27022	Blue	12	0.1-0.5	912	Class 2	MM	3	300-S-B	79862
27023	Clear	12	0.1-0.5	912	Class 2	MM	3	300-S-C	79862
✓ 27112	Amber	12	0.1-0.5	912	Class 1	VM	3	300-S-A	79862
27113	Blue	12	0.1-0.5	912	Class 2	VM	3	300-S-B	79862
27061	Amber	12-80	0.5	912	Class 1	MB	3	300-S-A	79862

✓ = Top Seller | MB = Mirror Bracket Mount | MM = Magnetic Mount | VM = Vacuum Mount | FL = Flange Mount

**MEDIUM PROFILE LED BEACONS**  
*FLEET*

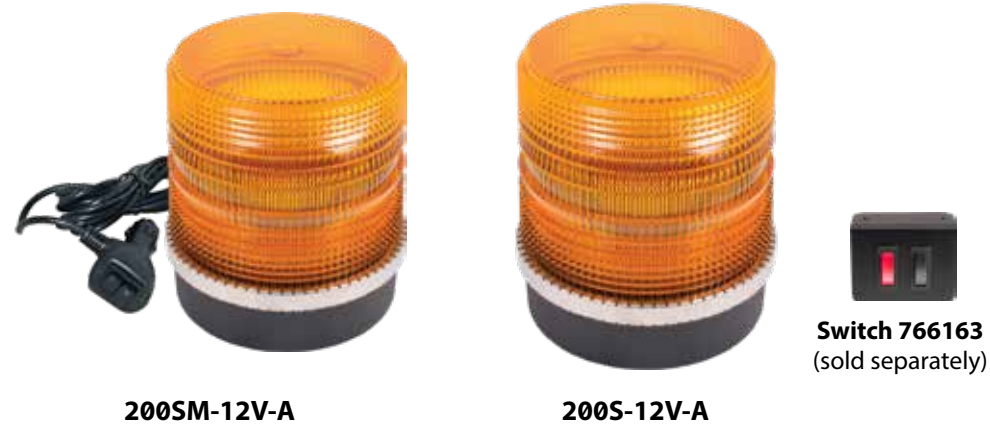

**200SM-12V-A**

**200S-12V-A**

**Switch 766163**  
(sold separately)

**Features**

- SAE J845 (2013) Class 1 requirements (Photometrics only)
- Polycarbonate closed base design and stainless steel banding ring
- Fully encapsulated electronics for rugged durability; protecting against vibration and moisture
- User selectable flash patterns; single (60 FPM), double (107 FPM) or quad (160 FPM)
- **4 Year Warranty**

**Available Colors**



**Recommended Mounting Solution**

(sold separately - See page 64 for more options)



**98017**  
Driver Side Mount

**98018**  
Passenger Side Mount

**Dimensions**

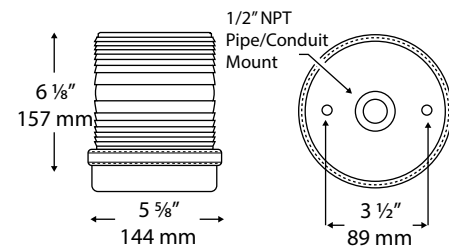

Available Models								Replacement parts	
Part #	Lens	Vdc	Amps	Lumens	SAE	Mounting	# Patterns	Lens	Circuit
✓ 200S-12V-A	Amber	12-80	0.5	912	Class 1	PM	3	300-S-A	79866
✓ 200S-12V-B	Blue	12-80	0.5	912	Class 2	PM	3	300-S-B	79866
200S-12V-C	Clear	12-80	0.5	912	Class 2	PM	3	300-S-C	79866
200S-72V-A	Amber	72-125	0.5	912	Class 1	PM	3	300-S-A	79868
200S-72V-C	Clear	72-125	0.5	912	Class 2	PM	3	300-S-C	79868
200S-72V-R	Red	72-125	0.5	912	Class 2	PM	3	300-S-R	79868
✓ 200SM-12V-A	Amber	12	0.1-0.5	912	Class 1	MM	3	300-S-A	79866
✓ 200SM-12V-B	Blue	12	0.1-0.5	912	Class 2	MM	3	300-S-B	79866

✓ = Top Seller | PM = Permanent Mount | MM = Magnetic Mount

**MEDIUM PROFILE LED BEACONS**  
*FLEET*

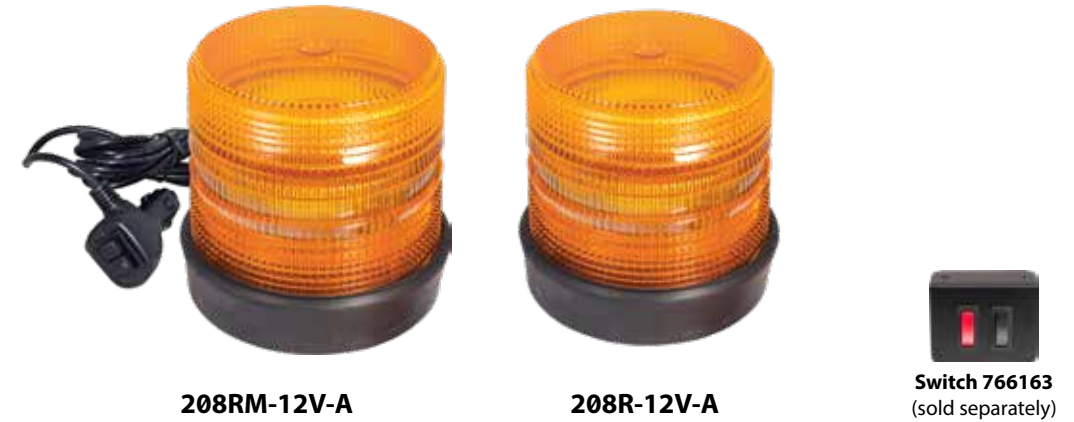

**208RM-12V-A**

**208R-12V-A**

**Switch 766163**  
(sold separately)

**Features**

- SAE J845 (2013) Class 2 (Photometrics only)
- Polycarbonate lens, corrosion proof silicone rubber base
- Fully encapsulated electronics for rugged durability; protecting against vibration and moisture
- User selectable flash patterns; single (60 FPM), double (107 FPM) or quad (160 FPM)
- **4 Year Warranty**

**Available Colors**



**Recommended Mounting Solution**

(sold separately - See page 64 for more options)



**98017**  
Driver Side Mount

**98018**  
Passenger Side Mount

**Dimensions**

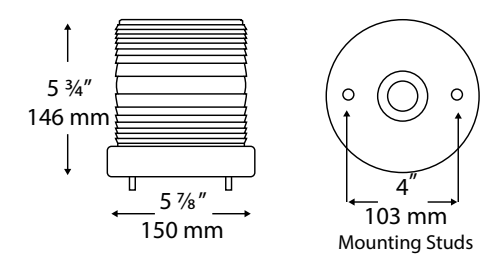

Available Models								Replacement parts	
Part #	Lens	Vdc	Amps	Lumens	SAE	Mounting	# Patterns	Lens	Circuit
✓ 208R-12V-A	Amber	12-80	0.5	456	Class 2	PM	3	299-A	79826
208R-12V-B	Blue	12-80	0.5	456	Class 2	PM	3	299-B	79826
208R-12V-C	Clear	12-80	0.5	456	Class 2	PM	3	299-C	79826
208R-12V-R	Red	12-80	0.5	456	Class 2	PM	3	299-R	79826
✓ 208RM-12V-A	Amber	12	0.1-0.5	456	Class 2	MM	3	299-A	79826
208RM-12V-B	Blue	12	0.1-0.5	456	Class 2	MM	3	299-B	79826

✓ = Top Seller | PM = Permanent Bracket Mount | MM = Magnetic Mount

NEW!

# MEDIUM PROFILE LED BEACONS FLEET PLUS



20640



Switch 766163  
(sold separately)

### Features

- SAE J845 (2013) Class 1 (Amber models CA13)
- Rugged polycarbonate base, lens, and dome with UV inhibitors
- Fully encapsulated electronics for rugged durability; protecting against vibration and moisture
- Replacement dome part number 877403

- 10 Year Warranty
- BatteryCheck™
- AutoDim™
- Synchronization
- Zero EMI

(definitions refer to page 2)

### Available Colors



### Recommended Mounting Solution

(sold separately - See page 64 for more options)

98017  
Driver Side  
Mount



98018  
Passenger Side  
Mount



### Dimensions

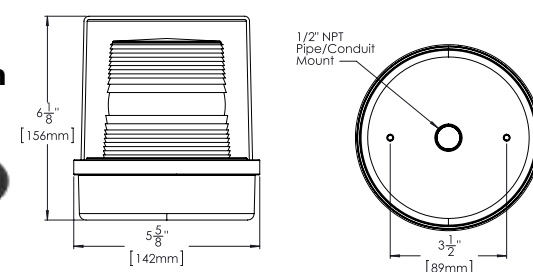

Available Models								Replacement parts
Part #	Lens/Dome	Vdc	Amps	Lumens	SAE	Mounting	# Patterns	Lens
✓20640	Amber/Clear	10-16	0.2-0.5	810	Class 1	PM	14	333-A
20641	Blue/Clear	10-16	0.2-0.5	621	Class 2	PM	14	333-B
20642	Clear/Clear	10-16	0.2-0.5	810	Class 1	PM	14	333-C
20643	Green/Clear	10-16	0.2-0.5	810	Class 2	PM	14	333-G
20655	Red/Clear	10-16	0.2-0.5	810	Class 2	PM	14	333-R
✓20610	Amber/Clear	12	0.2-0.5	810	Class 1	MM	14	333-A
20611	Blue/Clear	12	0.2-0.5	621	Class 2	MM	14	333-B
20612	Clear/Clear	12	0.2-0.5	810	Class 1	MM	14	333-C
20613	Green/Clear	12	0.2-0.5	810	Class 2	MM	14	333-G
20615	Red/Clear	12	0.2-0.5	810	Class 2	MM	14	333-R

✓ = Top Seller | PM = Permanent Mount | MM = Magnetic Mount

NEW!

# MEDIUM PROFILE LED BEACONS FLEET



20650



Switch 766163  
(sold separately)

### Features

- SAE J845 (2013) Class 2 (Photometrics only)
- Rugged polycarbonate base, lens, and dome with UV inhibitors
- Fully encapsulated electronics for rugged durability; protecting against vibration and moisture
- User selectable flash patterns; single (60 FPM), double (107 FPM) or quad (160 FPM)
- 4 Year Warranty

### Available Colors



### Recommended Mounting Solution

(sold separately - See page 64 for more options)

98017  
Driver Side  
Mount



98018  
Passenger Side  
Mount



### Dimensions

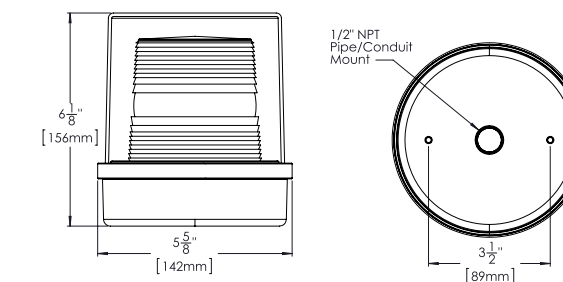

Available Models								Replacement parts	
Part #	Lens/Dome	Vdc	Amps	Lumens	Mounting	# Patterns	Lens	Dome	
✓20650	Amber/Clear	12-80	0.3-0.4	912	PM	3	333-A	877403	
20651	Blue/Clear	12-80	0.3-0.4	912	PM	3	333-B	877403	
20652	Clear/Clear	12-80	0.3-0.4	912	PM	3	333-C	877403	
20653	Green /Clear	12-80	0.3-0.4	912	PM	3	333-G	877403	
20655	Red/Clear	12-80	0.3-0.4	912	PM	3	333-R	877403	
✓20660	Amber/Clear	12	0.3-0.4	912	MM	3	333-A	877403	
20661	Blue/Clear	12	0.3-0.4	912	MM	3	333-B	877403	
20662	Clear/Clear	12	0.3-0.4	912	MM	3	333-C	877403	
20663	Green/Clear	12	0.3-0.4	912	MM	3	333-G	877403	
20665	Red/Clear	12	0.3-0.4	912	MM	3	333-R	877403	

✓ = Top Seller | PM = Permanent Mount | MM = Magnetic Mount

## LOW PROFILE LED BEACONS FLEET PLUS

## LOW PROFILE LED BEACONS FLEET



23101



23817



Switch 766163  
(sold separately)



23715



27006



27066  
Mirror bracket mount



Switch 766163  
(sold separately)

- **10 Year Warranty** 238xx Series
- **BatteryCheck™**
- **AutoDim™**
- **Synchronization**
- **Zero EMI** 238xx Series



(definitions refer to page 2)

### Features

- SAE J845 (2013) Class 1 requirements (Amber models only)
- High strength polycarbonate construction with UV inhibitors
- Fully encapsulated electronics for rugged durability; protecting against vibration and moisture
- AutoDim™ and Synchronization not available in magnetic mount versions
- 231xx **5 Year Warranty**



Magnet Mount Kit  
(sold separately for 23715 only)

### Features

- SAE J845 (2013) Class 2 (Photometrics only)
- High strength polycarbonate construction with UV inhibitors
- Fully encapsulated electronics for rugged durability; protecting against vibration and moisture
- User selectable flash patterns; single (60 FPM), double (107 FPM) or quad (160 FPM)
- Multiple mounting options for your application
- **4 Year Warranty**

### Available Colors



### Recommended Mounting Solution

(sold separately - See page 64 for more options)



### Dimensions

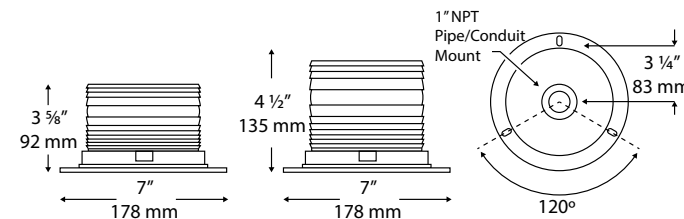

### Available Colors



### Recommended Mounting Solution

(sold separately - See page 64 for more options)



### Dimensions

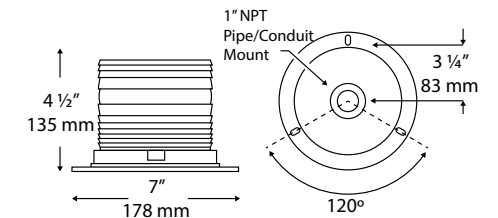

Available Models								Replacement parts	
Part #	Lens	Vdc	Amps	Lumens	SAE	Mounting	# Patterns	Lens	Circuit
✓ 23817	Amber	12-24	0.1-1.5	1080	Class 1	PM	13	877334	79896
23821	Blue	12-24	0.1-1.5	828	Class 2	PM	13	877335	79898
✓ 23818	Amber	12	0.1-1.5	1080	Class 1	MM	13	877334	79896
23822	Blue	12	0.1-1.5	828	Class 2	MM	13	877335	79898
23101	Amber	12-24	0.1 - 1.3	1824	Class 1	FL	23	877461	-
23105	Blue	12-24	0.1 - 1.3	1824	Class 2	FL	23	877463	-
23109	Clear	12-24	0.1 - 1.3	1824	Class 2	FL	23	877459	-
23102	Amber	12	0.1 - 1.3	1824	Class 1	MM	23	877461	-
23106	Blue	12	0.1 - 1.3	1824	Class 2	MM	23	877463	-

✓ = Top Seller | PM = Permanent Mount | MM = Magnetic Mount | FL = Flange Mount

Available Models								Replacement parts	
Part #	Lens	Vdc	Amps	Lumens	SAE	Mounting	# Patterns	Lens	Circuit
✓ 27006	Amber	12-80	0.1-0.5	912	Class 2	FL	3	877334	79866
27007	Blue	12-80	0.1-0.5	912	Class 2	FL	3	877335	79866
27008	Clear	12-80	0.1-0.5	912	Class 2	FL	3	877337	79866
27016	Amber	72-125	0.1	912	Class 2	FL	3	877334	79868
27020	Red	72-125	0.1	912	Class 2	FL	3	877336	79868
✓ 27026	Amber	12	0.1-0.5	912	Class 2	MM	3	877334	79866
✓ 27027	Blue	12	0.1-0.5	912	Class 2	MM	3	877335	79866
✓ 27066	Amber	12-80	0.1-0.5	912	Class 2	MB	3	877334	79866
27067	Blue	12-80	0.1-0.5	912	Class 2	MB	3	877335	79866
23715	Amber	12-24	0.1-1.5	1,080	Class 2	PM	13	877334	79896

✓ = Top Seller | MB = Mirror Bracket Mount | MM = Magnetic Mount | PM = Permanent Mount | FL = Flange Mount

**NEW!**

# LOW PROFILE LED BEACONS FLEET<sup>PLUS</sup>



20790



20760



Switch 766163  
(sold separately)

### Features

- SAE J845 (2013) Class 1 requirements (Amber & White models only)
- Polycarbonate lens, powder coated die-cast base and stainless steel banding ring
- Fully encapsulated electronics for rugged durability; protecting against vibration and moisture
- AutoDim™ and Synchronization not available in magnetic mount versions

- 10 Year Warranty
- BatteryCheck™
- AutoDim™
- Synchronization
- Zero EMI

(definitions refer to page 2)

### Available Colors



### Recommended Mounting Solution

(sold separately - See page 64 for more options)

98008

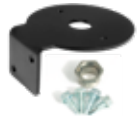

### Dimensions

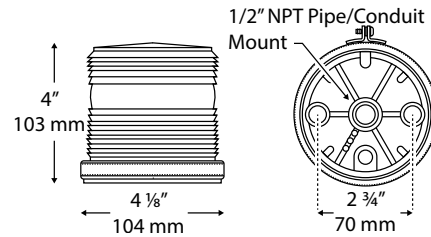

Available Models								Replacement parts	
Part #	Lens	Vdc	Amps	Lumens	SAE	Mounting	# Patterns	Lens	Circuit
✓ 20790	Amber	10-16	0.2-0.5	810	Class 1	PM	14	330-A	79880
20791	Blue	10-16	0.2-0.5	621	Class 2	PM	14	330-B	79891
20792	Clear	10-16	0.2-0.5	810	Class 1	PM	14	330-C	79888
20793	Red	10-16	0.2-0.5	810	Class 2	PM	14	330-R	79880
✓ 20760	Amber	12	0.2-0.5	810	Class 1	MM	14	330-A	79879
20761	Blue	12	0.2-0.5	621	Class 2	MM	14	330-B	79886
20762	Clear	12	0.2-0.5	810	Class 1	MM	14	330-C	79884
20765	Red	12	0.2-0.5	810	Class 2	MM	14	330-R	79879

✓ = Top Seller | PM = Permanent Mount | MM = Magnetic Mount

# LOW PROFILE LED BEACONS FLEET

**SWS**



200Z-12V-A



200ZM-12V-A



Switch 766163  
(sold separately)

### Features

- SAE J845 (2013) Class 2 (Photometrics only)
- Polycarbonate lens, powder coated die-cast base and stainless steel banding ring
- Fully encapsulated electronics for rugged durability; protecting against vibration and moisture
- User selectable flash patterns; single (60 FPM), double (107 FPM) or quad (160 FPM)
- 4 Year Warranty

### Available Colors



### Recommended Mounting Solution

(sold separately - See page 64 for more options)

98008



### Dimensions

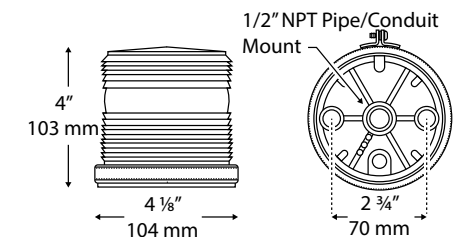

Available Models								Replacement parts	
Part #	Lens	Vdc	Amps	Lumens	SAE	Mounting	# Patterns	Lens	Circuit
✓ 200Z-12V-A	Amber	12-80	0.1-0.5	456	Class 2	PM	3	330-A	79822
200Z-12V-B	Blue	12-80	0.1-0.5	456	Class 2	PM	3	330-B	79822
200Z-12V-C	Clear	12-80	0.1-0.5	456	Class 2	PM	3	330-C	79822
✓ 200ZM-12V-A	Amber	12	0.1-0.5	456	Class 2	MM	3	330-A	79822
200ZM-12V-B	Blue	12	0.1-0.5	456	Class 2	MM	3	330-B	79822
200ZM-12V-G	Green	12	0.1-0.5	456	Class 2	MM	3	330-G	79822
200ZM-12V-M	Magenta	12	0.1-0.5	456	Class 2	MM	3	330-M	79822

✓ = Top Seller | MM = Magnetic Mount | PM = Permanent Mount

**NEW!**

# LOW PROFILE LED BEACONS

## FLEET *PLUS*



20796



20780



20796B



Switch 766163  
(sold separately)

### Features

- SAE J845 (2013) Class 1 requirements (Amber & White models only)
- Polycarbonate base with snap-in polycarbonate fresnel lens
- Fully encapsulated electronics for rugged durability; protecting against vibration and moisture
- AutoDim™ and Synchronization not available in magnetic mount versions

- **10 Year Warranty**
- **BatteryCheck™**
- **AutoDim™**
- **Synchronization**
- **Zero EMI**  
*(No radio interference)*  
*(definitions refer to page 2)*

### Available Colors



### Recommended Mounting Solution

(sold separately - See page 64 for more options)

98008



### Dimensions

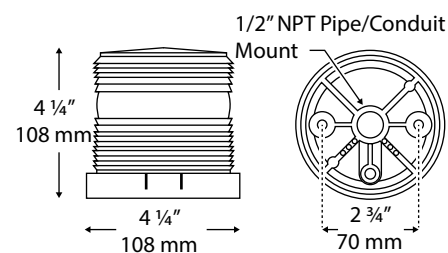

Available Models								Replacement parts	
Part #	Lens	Vdc	Amps	Lumens	SAE	Mounting	# Patterns	Lens	Circuit
✓ 20796	Amber	10-16	0.2-0.5	810	Class 1	PM	14	330-A	79880
20797	Blue	10-16	0.2-0.5	621	Class 2	PM	14	330-B	79891
20798	Clear	10-16	0.2-0.5	810	Class 1	PM	14	330-C	79888
20799	Red	10-16	0.2-0.5	810	Class 2	PM	14	330-R	79880
✓ 20780	Amber	12	0.2-0.5	810	Class 1	MM	14	330-A	79879
20781	Blue	12	0.2-0.5	621	Class 2	MM	14	330-B	79886
20782	Clear	12	0.2-0.5	810	Class 1	MM	14	330-C	79884
20785	Red	12	0.2-0.5	810	Class 2	MM	14	330-R	79879
20796B	Amber	10-16	0.2-0.5	810	Class 1	MB	14	330-A	79880

✓ = Top Seller | PM = Permanent Mount | MM = Magnetic Mount | MB = Mirror Bracket Mount

# LOW PROFILE LED BEACONS

## FLEET

**SWS**



201Z-12V-A



201ZM-12V-A



201ZB-12V-A



201ZS-12V-A



Switch 766163  
(sold separately)

### Features

- SAE J845 (2013) Class 2 (Photometrics only)
- Polycarbonate base with snap-in polycarbonate fresnel lens
- Fully encapsulated electronics for rugged durability; protecting against vibration and moisture
- User selectable flash patterns; single (60 FPM), double (107 FPM) or quad (160 FPM)
- Permanent or 1/2" NPT mount standard
- Magnetic mount, mirror bracket mount & suction cup mount available
- **4 Year Warranty**

### Available Colors



### Recommended Mounting Solution

(sold separately - See page 64 for more options)

98008

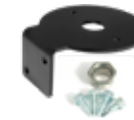

### Dimensions

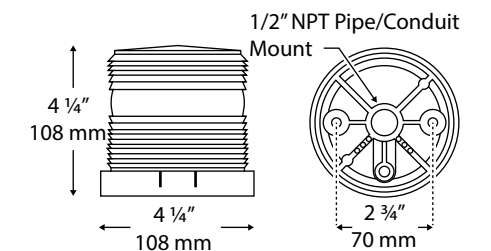

Available Models								Replacement parts	
Part #	Lens	Vdc	Amps	Lumens	SAE	Mounting	# Patterns	Lens	Circuit
✓ 201Z-12V-A	Amber	12-80	0.1-0.5	456	Class 2	PM	3	330-A	79822
201Z-12V-B	Blue	12-80	0.1-0.5	456	Class 2	PM	3	330-B	79822
201Z-12V-C	Clear	12-80	0.1-0.5	456	Class 2	PM	3	330-C	79822
✓ 201ZM-12V-A	Amber	12	0.1-0.5	456	Class 2	MM	3	330-A	79822
201ZM-12V-B	Blue	12	0.1-0.5	456	Class 2	MM	3	330-B	79822
201ZM-12V-G	Green	12	0.1-0.5	456	Class 2	MM	3	330-G	79822
201ZM-12V-M	Magenta	12	0.1-0.5	456	Class 2	MM	3	330-M	79822
✓ 201ZB-12V-A	Amber	12-80	0.1-0.5	456	Class 2	MB	3	330-A	79822
201ZB-12V-B	Blue	12-80	0.1-0.5	456	Class 2	MB	3	330-B	79822
✓ 201ZS-12V-A	Amber	12	0.1-0.5	456	Class 2	SC	3	330-A	79822

✓ = Top Seller | MM = Magnetic Mount | PM = Permanent Mount | MB = Mirror Bracket Mount | SC = Suction Cup Mount



## LOW PROFILE LED BEACONS FLEET



204R-12V-A



204RM-12V-A



Switch 766163  
(sold separately)

### Features

- SAE J845 (2013) Class 2 (Photometrics only)
- Polycarbonate lens, scratch resistant silicone rubber base and corrosion proof housing
- Fully encapsulated electronics for rugged durability; protecting against vibration and moisture
- User selectable flash patterns; single (60 FPM), double (107 FPM) or quad (160 FPM)
- **4 Year Warranty**

### Available Colors



### Recommended Mounting Solution

(sold separately - See page 64 for more options)



### Dimensions

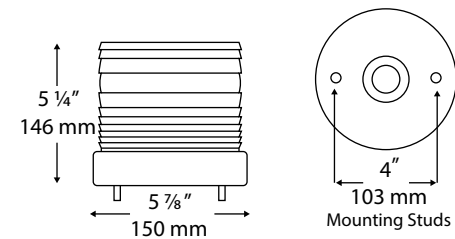

Available Models								Replacement parts	
Part #	Lens	Vdc	Amps	Lumens	SAE	Mounting	# Patterns	Lens	Circuit
✓ 204R-12V-A	Amber	12-80	0.1-0.5	456	Class 2	PM	3	298-A	79821
204R-12V-B	Blue	12-80	0.1-0.5	456	Class 2	PM	3	298-B	79821
204R-12V-C	Clear	12-80	0.1-0.5	456	Class 2	PM	3	298-C	79821
✓ 204RM-12V-A	Amber	12	0.1-0.5	456	Class 2	MM	3	298-A	79821
204RM-12V-B	Blue	12	0.1-0.5	456	Class 2	MM	3	298-B	79821

✓ = Top Seller | PM = Permanent Mount | MM = Magnetic Mount

## DUAL COLOR LED BEACONS FLEET PLUS



LOW



MEDIUM



HIGH

### Common Color Combinations



- **5 Year Warranty**
- **Synchronization**

(definitions refer to page 2)



Switch 766152  
(sold separately)

### Recommended Mounting Solution

(sold separately - See page 64 for more options)

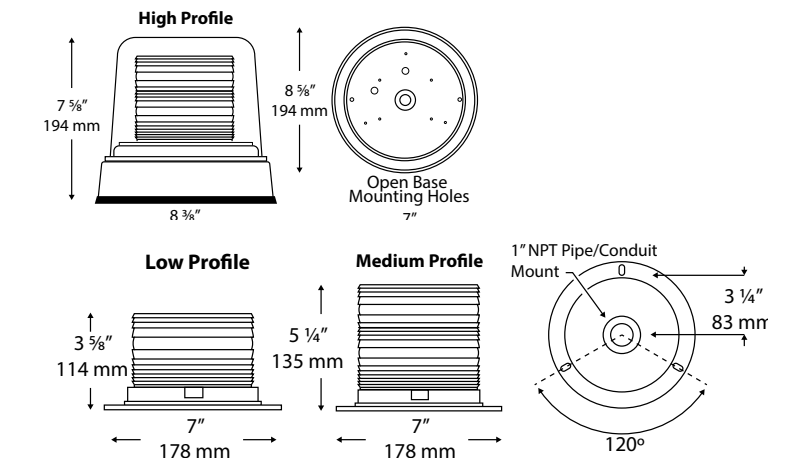

Available Models										Replacement parts
Part #	Profile	Dome/Lens/Flash	Vdc	Amps	Lumens	SAE	Mounting	# Patterns		Dome / Lens
✓ 22117	Low	- /Clear/A-B	12-24	0.1-0.7	A: 454 B: 320	Class 2	FL	3		877456
✓ 22332	Medium	- /Clear/A-B	12-24	0.1-0.9	A: 908 B: 640	Class 2	FL	23		877451
✓ 22335	Medium	- /Clear/A-B	12-24	0.1-0.8	A: 908 B: 640	Class 2	FL	3		877451
22336	Medium	- /Clear/A-B	12-24	0.1-0.9	A: 908 B: 640	Class 2	FL	3		877451
22609	High	Clear/Clear/A-B	12-24	0.2-1.4	A: 908 B: 640	Class 1	PM	3		134-1-C / 877452

✓ = Top Seller | A = Amber | B=Blue | PM= Permanent Mount | FL=Flange Mount

# ROTATOR BEACONS FLEET



28100



28001



Switch 766150  
(sold separately)

### Available Colors



### Recommended Mounting Solution

(sold separately - See page 64 for more options)

98017  
Driver Side  
Mount



98018  
Passenger Side  
Mount



98004  
Passenger Side Mount  
High Profile Beacon



98005  
Driver Side Mount  
High Profile Beacon



### Features

- SAE J845 (2013) Class 1
- High Profile: Anodized aluminum base, open bottom design
- Medium Profile: Polycarbonate base, optional flange included
- Polycarbonate dome
- Gear driven rotator assembly with stainless steel bearings and vibration resistant mounts for long life
- Magnetic mount versions available
- **1 Year Warranty** (on rotator assembly)

### Dimensions

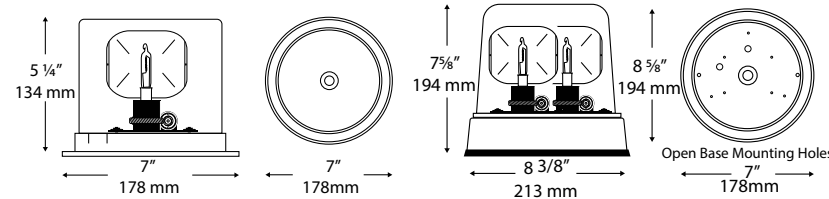

Available Models								Replacement parts	
Part #	Lens	Vdc	Amps	Watts	SAE	Mounting	FPM	Lens	Bulb
<b>Medium Profile</b>									
✓ 28001	Amber	12	3	35	Class 1	FL	85	877401	2073-796
28002	Blue	12	3	35	Class 1	FL	85	877402	2073-796
28003	Clear	12	3	35	Class 1	FL	85	877403	2073-796
28031	Amber	24	1.5	35	Class 1	FL	85	877401	2073-H50W24V
28032	Blue	24	1.5	35	Class 1	FL	85	877402	2073-H50W24V
✓ 28011	Amber	12	3	35	Class 1	MM	85	877401	2073-796
28012	Blue	12	3	35	Class 1	MM	85	877402	2073-796
28014	Green	12	3	35	Class 1	MM	85	877404	2073-796
<b>High Profile</b>									
✓ 28100	Amber	12	6	70	Class 1	PM	170	134-1-A	2073-796
28101	Blue	12	6	70	Class 1	PM	170	134-1-B	2073-796
28105	Amber	24	3	70	Class 1	PM	170	134-1-A	2073-H50W24V
28106	Blue	24	3	70	Class 1	PM	170	134-1-B	2073-H50W24V

✓ = Top Seller | MM = Magnetic Mount | PM = Permanent Mount | FL = Flange Mount

**SWS**

eclipse

At just 2" in height, the new Eclipse mini lightbar from SWS is one of the slimmest profile lights on the market.

Despite its slim profile, it sacrifices nothing in regards to visibility, durability, and reliability.

- Ultra efficient LEDs and dual-beam optics drive it beyond SAE Class 1 standards for omni-directional devices.
- Its precision molded outer dome and die-cast aluminum base protect the critical electrical components from unforgiving environments.

The wide selection of colors, mounting options, and unparalleled technical features ensure that there is an Eclipse for your application.

